

KOMATSU®

PC130-8

HORSEPOWER

Gross: 72.1 kW 96.6 HP @ 2200 rpm

Net: 68.4 kW 91.7 HP @ 2200 rpm

OPERATING WEIGHT

12380–12740 kg 27,300–28,100 lb

BUCKET CAPACITY

0.18–0.6 m³ 0.24–0.78 yd³

ecot3

PC
130



Photo may include optional equipment.

HYDRAULIC EXCAVATOR

WALK-AROUND

Ecology and Economy Features

• Low emission engine

A powerful, turbocharged and air-to-air aftercooled Komatsu SAA4D95LE-5 provides **68.4 kW** 91.7 HP. This engine is EPA Tier 3 and EU Stage 3A emissions certified, without sacrificing power or machine productivity.

• Low operation noise

The dynamic noise is reduced providing low noise operation.

See pages 4 and 5

Productivity Features

- Larger maximum drawbar pull
- Mode selection
 - Economy mode improves fuel consumption.
 - Eco-gauge for energy-saving operations
 - Extended idling caution for fuel conservation

See page 5.

Safety Design

- ROPS cab (ISO 12117-2)
- Slip-resistant plates for safe work on machine
- Safety enhancement with large side-view, sidewise, rear and front under-view mirrors added.
- Rear view monitoring system for easy checking behind the machine (optional)

See pages 6 and 7.



Large TFT LCD Monitor

- Easy-to-see and use 7" large multi-function color monitor
- Can be displayed in 12 languages for global support.

TFT : Thin Film Transistor
LCD : Liquid Crystal Display

See page 9.

Large Comfortable Cab

- Low-noise cab, similar to passenger car
- Low vibration with cab damper mounting
- Highly pressurized cab with automatic air conditioner
- Operator seat and console with armrest that enables operations in the appropriate operational posture.

See page 6.

Easy Maintenance

- Long replacement interval of engine oil, engine oil filter, and hydraulic filter
- Remote mounted engine oil filter, engine main fuel filter and fuel drain valve for easy access
- Equipped with the fuel pre-filter as standard (with water separator)
- Side-by-side cooling concept enables individual cooling modules to be serviced.
- Equipped with the EMMS monitoring system

See pages 8 and 9.



Excellent Reliability and Durability

- High rigidity work equipment
- Sturdy frame structure
- Reliable Komatsu manufactured major components

See page 9.

Photo may include optional equipment.

HORSEPOWER
Gross: 72.1 kW 96.6 HP @ 2200 rpm
Net: 68.4 kW 91.7 HP @ 2200 rpm

OPERATING WEIGHT
12380 – 12740 kg
27,300 – 28,100 lb

BUCKET CAPACITY
0.18 – 0.6 m³
0.24 – 0.78 yd³

PRODUCTIVITY & ECOLOGY FEATURES

Komatsu Technology



Komatsu develops and produces all major components in house such as engines, electronics and hydraulic components. Combining "Komatsu Technology", and customer feedback, Komatsu is achieving great advancements in technology. To achieve both high levels of productivity and economical performance, Komatsu has developed the main components with a total control system. The result is a new generation of high performance and environment-friendly excavators.

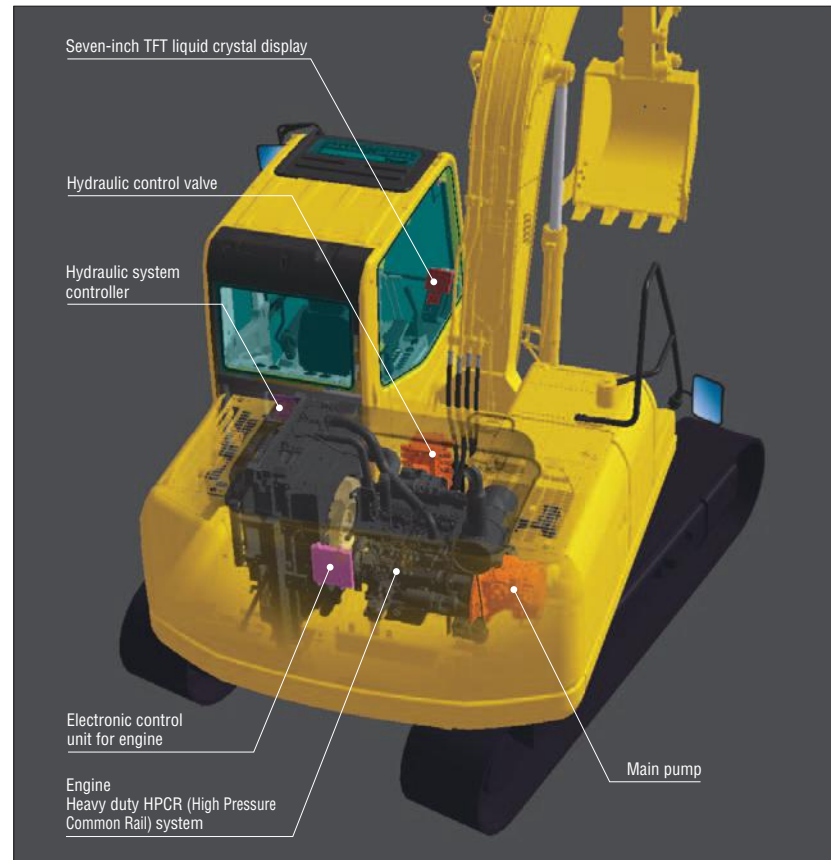
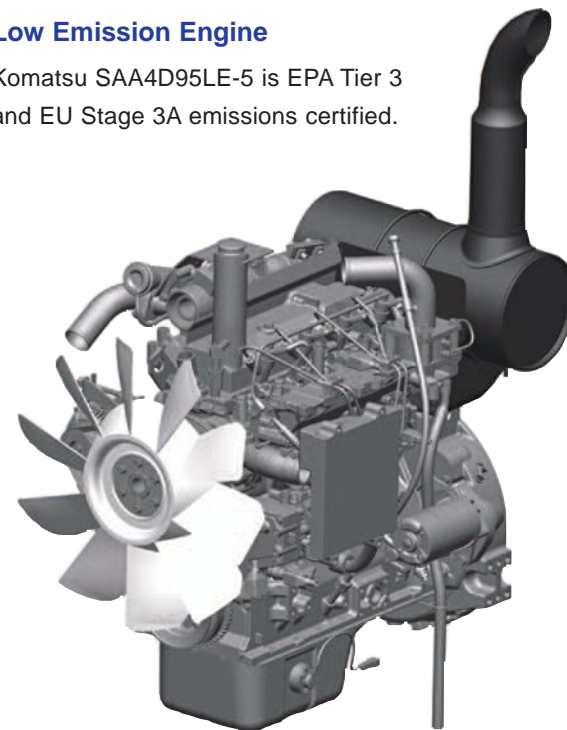

Photo may include optional equipment.

Low Emission Engine

Komatsu SAA4D95LE-5 is EPA Tier 3 and EU Stage 3A emissions certified.



Low Operation Noise

Enables low noise operation using the low-noise engine and methods to cut noise at source.

Electronically controlled common rail type engine

- Multi-staged injection

Low noise design

- Optimal arrangement of sound absorbing materials
- Partition between the cab and engine room

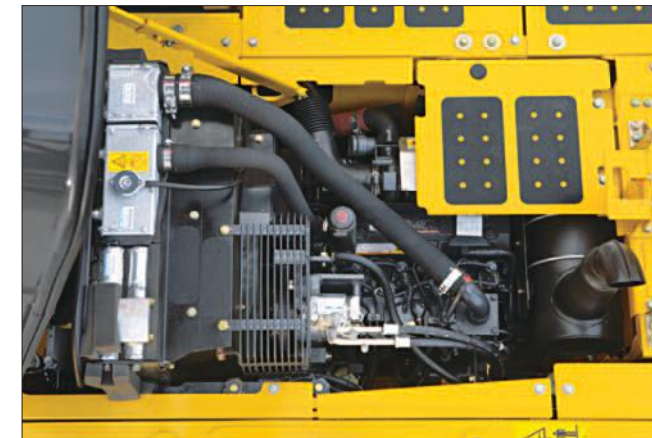

Larger Maximum Drawbar Pull

Larger maximum drawbar pull provides superb steering and slope climbing performance.

Maximum drawbar pull: 122.6 kN 12500 kgf 27,570 lb

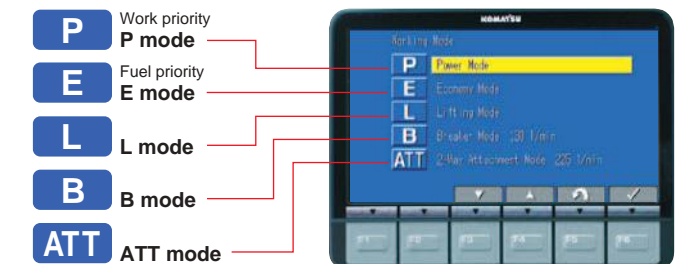

Photo may include optional equipment.

Working Modes Selectable

The PC130-8 excavator is equipped with five working modes (P, E, L, B and ATT mode). Each mode is designed to match engine speed and pump speed with the current application. This provides the flexibility to match equipment performance to the job at hand.

Working Mode	Application	Advantage
P	Power mode	<ul style="list-style-type: none"> • Maximum production/power • Fast cycle times
E	Economy mode	<ul style="list-style-type: none"> • Good cycle times • Better fuel economy
L	Lifting mode	<ul style="list-style-type: none"> • Suitable attachment speed
B	Breaker mode	<ul style="list-style-type: none"> • Optimum engine rpm, hydraulic flow
ATT	Attachment mode	<ul style="list-style-type: none"> • Optimum engine rpm, hydraulic flow, 2way



Eco-gauge that Assists Energy-saving Operations

The Eco-gauge on the right side of the multi-function color monitor provides environment-friendly energy-saving operation. Allows focus on operation in the green range with reduced CO₂ emissions and efficient fuel consumption.



Idling Caution

To prevent unnecessary fuel consumption, an idling caution is displayed on the monitor, if the engine idles for 5 minutes or more.



WORKING ENVIRONMENT



Low Cab Noise

The newly-designed cab is highly rigid and has excellent sound absorption ability. Thorough improvement of noise source reduction and use of low noise engine, hydraulic equipment, and air conditioner allows this machine to generate a low level of noise similar to that of a passenger car.

Low Vibration with Cab Damper Mounting

PC130-8 uses viscous damper mounting for cab that incorporates longer stroke and the addition of a spring. The new cab damper mounting combined with high rigidity deck aids vibration reduction at operator seat.

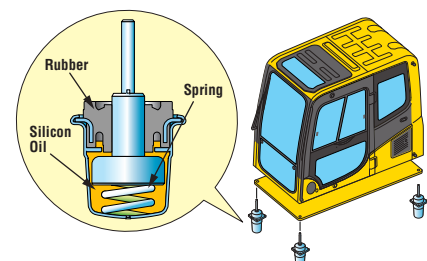

Wide Newly-designed Cab

Newly-designed wide spacious cab includes seat with reclining backrest. The seat height and longitudinal inclination are easily adjusted using a pull-up lever. You can set the appropriate operational posture of armrest together with the console. Reclining the seat further enables you to place it into the fully flat state with the headrest attached.



Pressurized Cab

Air conditioner, air filter and a higher internal air pressure (+6.0 mm Aq +0.2"Aq) prevent external dust from entering the cab.

Automatic Air Conditioner

Enables you to easily and precisely set cab atmosphere with the instruments on the large LCD. The bi-level control function keeps the operator's head and feet cool and warm respectively. This improved air flow function keeps the inside of the cab comfortable throughout the year. Defroster function keeps front glass clear.

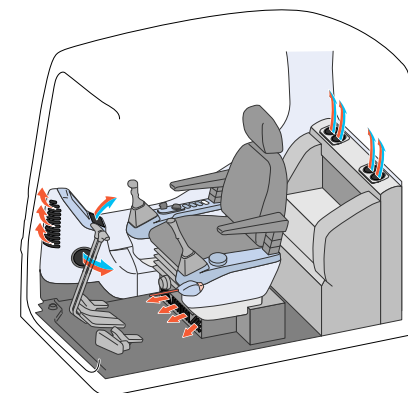

Safety Features

ROPS Cab

The machine is equipped with a ROPS cab that conforms to ISO 12117-2 for excavators as standard equipment. The ROPS cab has high shock-absorption performance, featuring excellent durability and impact strength. It also satisfies the requirements of ISO OPG top guard level 1 for falling objects. Combined with the retractable seat belt, The ROPS cab protects the operator in case of tipping over and against falling objects.

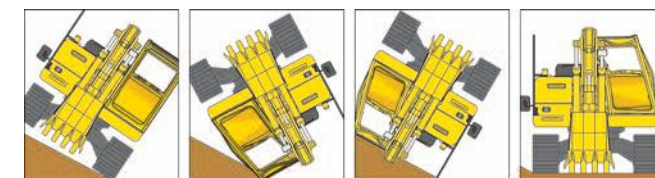

Slip-resistant Plates

Highly durable slip-resistant plates maintain superior traction performance for the long term.



Pump/engine Room Partition

Pump/engine room partition prevents oil from spraying onto the engine if a hydraulic hose should burst.

Lock Lever

Locks the hydraulic pressure to prevent unintentional movement. Neutral start function allows machine to be started only in lock position.



Large Side-view, Sidewise, Rear and Front Under-view Mirrors

Enlarged side mirrors and addition of front under mirror allow the PC130-8 to meet the new ISO visibility requirements.



Rear View Monitoring System (optional)

The operator can view the rear of the machine with a color monitor screen.

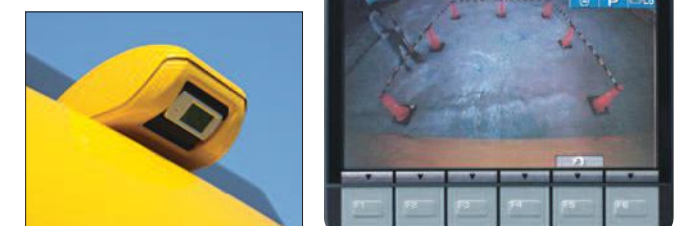

Monitor for rear view camera

Thermal and Fan Guards

Thermal and fan guards are placed around high-temperature parts of the engine and fan drive.



MAINTENANCE FEATURES

Side-by-side Cooling

Since radiator, aftercooler and oil cooler are arranged in parallel, it is easy to clean, remove and install them. Radiator, aftercooler, and oil cooler made of aluminum have high cooling efficiency and are easily recycled.



Equipped with the Fuel Pre-filter (with Water Separator)

Removes water and contaminants in the fuel to prevent fuel problems. (with built-in priming pump)



Washable Cab Floor Mat

The PC130-8's cab floor mat is easy to keep clean. The gently inclined surface has a flanged floor mat and drainage holes to facilitate runoff.



Easy Access to Engine Oil Filter, Engine Main Fuel Filter and Fuel Drain Valve

Engine oil filter, engine main fuel filter and fuel drain valve are remote mounted to improve accessibility.

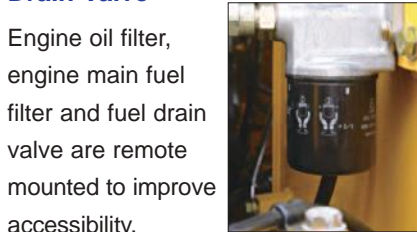

Equipped with the Eco-drain Valve as Standard.

Prevents clothes and the ground from becoming contaminated due to oil leakage when replacing the engine oil.



Large-capacity Fuel Tank and Rustproof Treatment

247 liter 65.3 U.S. gal high-capacity fuel tank. Effective corrosion resistance using rustproof treatment.

Sloping Track Frame

Prevents dirt and sand from accumulating and allows easy mud removal.

Long-life Oil, Filter

Uses high-performance filtering materials and long-life oil. Extends the oil and filter replacement interval.



Hydraulic oil filter (Eco-white element)

- Engine oil & Engine oil filter every **500** hours
- Hydraulic oil every **5000** hours
- Hydraulic oil filter every **1000** hours

Air Conditioner Filter

The air conditioner filter is removed and installed without the use of tools facilitating filter maintenance.



Internal air conditioner filter



External air conditioner filter

Long Greasing Interval (optional)

High quality bushings are optionally available for work equipment pins except arm top pin. All bushing lubrication intervals of work equipment except arm top bushings are 500 hours, reducing maintenance cost.

Large TFT LCD Monitor

Large Multi-lingual LCD Monitor

A large user-friendly color monitor enables safe, accurate and smooth work. Improved screen visibility is achieved by the use of TFT liquid crystal display that can easily be read at various angles and lighting conditions. Simple and easy to operate switches. Industry first function keys facilitate multi-function operations. Displays data in 12 languages to globally support operators around the world.



- Indicators**
- 1 Auto-decelerator
 - 2 Working mode
 - 3 Travel speed
 - 4 Engine water temperature gauge
 - 5 Hydraulic oil temperature gauge
 - 6 Fuel gauge
 - 7 Eco-gauge
 - 8 Function switches menu
- Basic operation switches**
- 1 Auto-decelerator
 - 2 Working mode selector
 - 3 Traveling selector
 - 4 Buzzer cancel
 - 5 Wiper
 - 6 Windshield washer

EMMS (Equipment Management Monitoring System)

Monitor function

Controller monitors engine oil level, coolant temperature, battery charge and air clogging, etc. If controller finds any abnormality, it is displayed on the LCD.



Maintenance function

Monitor informs replacement time of oil and filters on LCD when the replacement interval is reached.



Trouble data memory function

Monitor stores abnormalities for effective troubleshooting.

Excellent Reliability and Durability

High Rigidity Work Equipment

Boom and arms are constructed of thick plates of high tensile strength steel. In addition, these structures are designed with large cross-sectional areas and generous use of castings. The result is working attachments that exhibit long term durability and high resistance to bending and torsional stress.

Metal Guard Rings Protect all the Hydraulic Cylinders and Improve Reliability.

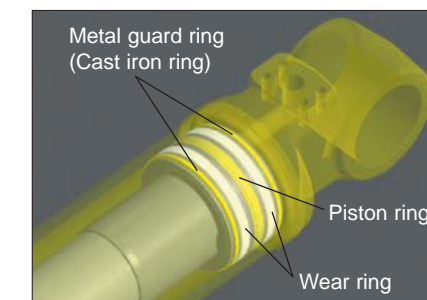

Reliable Components

All of the major machine components, such as engine, hydraulic pump, hydraulic motors and control valves are exclusively designed and manufactured by Komatsu.

DT-type Connectors

DT-type connectors seal tight and have higher reliability.

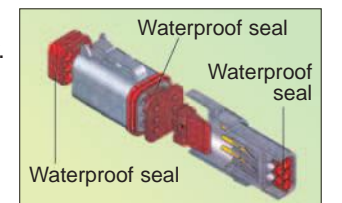

O-ring Face Seal

The hydraulic hose seal method has been changed from a conventional taper seal to an O-ring seal. This provides improved sealing performance.

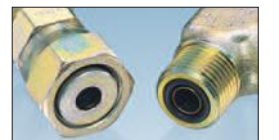

SPECIFICATIONS



ENGINE

Model Komatsu SAA4D95LE-5
 Type Water-cooled, 4-cycle, direct injection
 Aspiration Turbocharged, aftercooled
 Number of cylinders 4
 Bore 95 mm 3.74"
 Stroke 115 mm 4.53"
 Piston displacement 3.26 ltr 199 in³
 Horsepower:
 SAE J1995 Gross 72.1 kW 96.6 HP
 ISO 9249 / SAE J1349 Net 68.4 kW 91.7 HP
 Rated rpm 2200 rpm
 Fan drive method for radiator cooling Mechanical
 Governor All-speed control, electronic
 EPA Tier 3 and EU Stage 3A emissions certified



HYDRAULICS

Type HydraMind (Hydraulic Mechanical Intelligence New Design) system, closed-center system with load sensing valves and pressure compensated valves
 Number of selectable working modes 5
 Main pump:
 Type Variable displacement piston type
 Pumps for Boom, arm, bucket, swing, and travel circuits
 Maximum flow 241.5 ltr/min 63.8 U.S. gal/min
 Supply for control circuit Self-reducing valve
 Hydraulic motors:
 Travel 2 x axial piston motor with parking brake
 Swing 1 x axial piston motor with swing holding brake
 Relief valve setting:
 Implement circuits 31.9 MPa 325 kgf/cm² 4,620 psi
 Travel circuit 34.8 MPa 355 kgf/cm² 5,050 psi
 Swing circuit 24.7 MPa 252 kgf/cm² 3,580 psi
 Pilot circuit 3.2 MPa 33 kgf/cm² 470 psi
 Hydraulic cylinders:
 (Number of cylinders – bore x stroke x rod diameter)
 Boom 2–105 mm x 995 mm x 70 mm 4.1" x 39.2" x 2.8"
 Arm 1–115 mm x 1175 mm x 75 mm 4.5" x 46.3" x 3.0"
 Bucket 1–95 mm x 885 mm x 65 mm 3.7" x 34.8" x 2.6"



DRIVES AND BRAKES

Steering control Two levers with pedals
 Drive method Hydrostatic
 Maximum drawbar pull 122.6 kN 12500 kg 27,570 lb
 Gradeability 70%, 35°
 Maximum travel speed: High 5.5 km/h 3.4 mph
 Low 2.9 km/h 1.8 mph
 Service brake Hydraulic lock
 Parking brake Mechanical disc brake



SWING SYSTEM

Drive method Hydrostatic
 Swing reduction Planetary gear
 Swing circle lubrication Grease-bathed
 Service brake Hydraulic lock
 Holding brake/Swing lock Mechanical disc brake
 Swing speed 11.0 rpm



UNDERCARRIAGE

Center frame X-frame
 Track frame Box-section
 Seal of track Sealed track
 Track adjuster Hydraulic
 Number of shoes (each side) 43
 Number of carrier rollers (each side) 1
 Number of track rollers (each side) 7



COOLANT AND LUBRICANT CAPACITY (REFILLING)

Fuel tank 247 ltr 65.3 U.S. gal
 Coolant 13.9 ltr 3.7 U.S. gal
 Engine 11.5 ltr 3.0 U.S. gal
 Final drive, each side 2.1 ltr 0.6 U.S. gal
 Swing drive 2.5 ltr 0.7 U.S. gal
 Hydraulic tank 90 ltr 23.8 U.S. gal



OPERATING WEIGHT (APPROXIMATE)

Operating weight including 4600 mm 15'1" one-piece boom, 2500 mm 8'2" arm, SAE heaped 0.5 m³ 0.65 yd³ backhoe bucket, rated capacity of lubricants, coolant, full fuel tank, operator, and standard equipment.

Shoes	PC130-8	
	Operating Weight	Ground Pressure
500 mm 20"	12380 kg 27,300 lb	38.6 kPa 0.39 kgf/cm ² 5.60 psi
600 mm 24"	12560 kg 27,700 lb	32.6 kPa 0.33 kgf/cm ² 4.73 psi
700 mm 28"	12740 kg 28,100 lb	28.4 kPa 0.29 kgf/cm ² 4.12 psi



DIMENSIONS

Arm Length	2500 mm 8'2"	3000 mm 9'10"
A Overall length	7590 mm 24'11"	7485 mm 24'7"
B Length on ground (transport)	4410 mm 14'6"	4280 mm 14'1"
C Overall height (to top of boom)	2875 mm 9'5"	3185 mm 10'5"

D Overall width	2500 mm 8'2"
E Overall height (to top of cab)	2855 mm 9'4"
F Ground clearance, counterweight	895 mm 2'11"
G Ground clearance (minimum)	400 mm 1'4"
H Tail swing radius	2190 mm 7'2"
I Track length on ground	2880 mm 9'5"
J Track length	3610 mm 11'10"
K Track gauge	1990 mm 6'6"
L Width of crawler	2490 mm 8'2"
M Shoe width	500 mm 20"
N Grouser height	20 mm 0.8"
O Machine cab height	1925 mm 6'4"
P Machine cab width	2500 mm 8'2"
Q Distance, swing center to rear end	2110 mm 6'11"

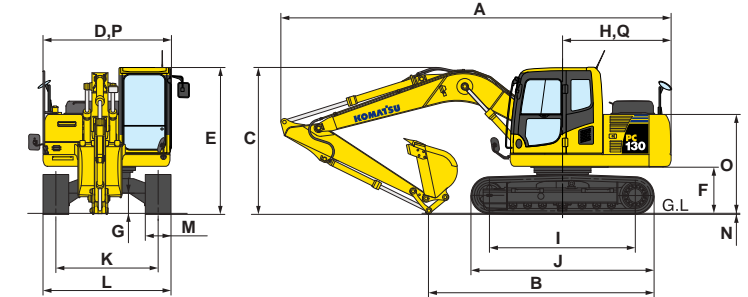

WORKING RANGE

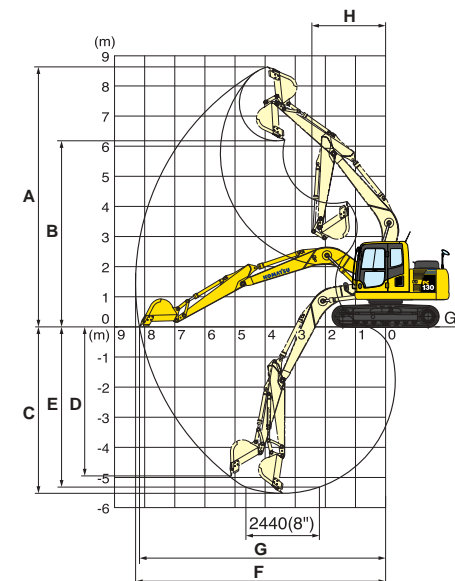

Arm	2500 mm 8'2"	3000 mm 9'10"	
A Max. digging height	8650 mm 28'5"	8930 mm 29'4"	
B Max. dumping height	6210 mm 20'4"	6615 mm 21'8"	
C Max. digging depth	5520 mm 18'1"	5955 mm 19'6"	
D Max. vertical wall digging depth	4980 mm 16'4"	5365 mm 17'7"	
E Max. digging depth of cut for 8' level	5320 mm 17'5"	5775 mm 18'11"	
F Max. digging reach	8290 mm 27'2"	8720 mm 28'7"	
G Max. digging reach at ground level	8170 mm 26'10"	8595 mm 28'2"	
H Min. swing radius	2450 mm 8'0"	2620 mm 8'7"	
SAE rating	Bucket digging force at power max.	80.9 kN 8250 kgf/18,190 lb	80.9 kN 8250 kgf/18,190 lb
	Arm crowd force at power max.	64.5 kN 6580 kgf/14,510 lb	56.8 kN 5800 kgf/12,790 lb
ISO rating	Bucket digging force at power max.	93.4 kN 9520 kgf/21,000 lb	93.4 kN 9520 kgf/21,000 lb
	Arm crowd force at power max.	67.5 kN 6880 kgf/15,170 lb	59.3 kN 6050 kgf/13,340 lb



BACKHOE BUCKET, ARM, AND BOOM COMBINATION

Bucket Capacity (heaped)		Width		Weight	Number of Teeth	Arm Length	
SAE, PCSA	CECE	Without Side Cutters	With Side Cutters			2500 mm 8'2"	3000 mm 9'10"
0.18 m ³ 0.24 yd ³	0.16 m ³ 0.21 yd ³	450 mm 17.7"	570 mm 22.4"	256 kg 565 lb	3	○	○
0.28 m ³ 0.37 yd ³	0.26 m ³ 0.34 yd ³	600 mm 23.6"	720 mm 28.3"	303 kg 670 lb	3	○	○
0.36 m ³ 0.50 yd ³	0.33 m ³ 0.43 yd ³	700 mm 27.6"	820 mm 32.3"	330 kg 730 lb	4	○	○
0.50 m ³ 0.65 yd ³	0.45 m ³ 0.59 yd ³	859 mm 33.8"	979 mm 38.5"	399 kg 880 lb	4	○	X
0.60 m ³ 0.78 yd ³	0.55 m ³ 0.72 yd ³	1000 mm 39.4"	NA	436 kg 960 lb	5	□	X

○—General digging □—Light-duty operation X—Not available



LIFTING CAPACITY WITH LIFTING MODE

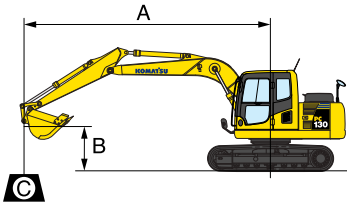

- A: Reach from swing center
- B: Bucket hook height
- C: Lifting capacity
- Cf: Rating over front
- Cs: Rating over side
- ⊗: Rating at maximum reach

Conditions:

- 4600 mm 15'1" one-piece boom
- 0.5 m³ 0.65 yd³ SAE heaped bucket
- 500 mm 20" triple-grouser shoe

PC130-8 Arm: 2500 mm 8'2" Bucket: 0.5 m ³ 0.65 yd ³ SAE heaped Shoe: 500 mm 20" triple grouser												
B	⊗ MAX		7.6 m 25'		6.1 m 20'		4.6 m 15'		3.0 m 10'		1.5 m 5'	
	Cf	Cs	Cf	Cs	Cf	Cs	Cf	Cs	Cf	Cs	Cf	Cs
7.6 m 25'												
6.1 m 20'	*1950 kg *4,300 lb	*1950 kg *4,300 lb										
4.6 m 15'	*1800 kg *4,000 lb	1650 kg 3,600 lb			2850 kg 6,200 lb	1950 kg 4,300 lb	*3100 kg *6,900 lb	*3100 kg *6,900 lb				
3.0 m 10'	*1800 kg *4,000 lb	1400 kg 3,100 lb			2750 kg 6,100 lb	1900 kg 4,200 lb	*3900 kg *8,600 lb	3100 kg 6,900 lb	*5000 kg *11,100 lb	*5000 kg *11,100 lb		
1.5 m 5'	1950 kg 4,300 lb	1300 kg 2,800 lb			2700 kg 5,900 lb	1800 kg 4,000 lb	4300 kg 9,500 lb	2900 kg 6,400 lb	*7700 kg *17,000 lb	5500 kg 12,100 lb		
0 m 0'	1950 kg 4,400 lb	1300 kg 2,900 lb			2600 kg 5,700 lb	1700 kg 3,800 lb	4100 kg 9,100 lb	2700 kg 6,000 lb	8350 kg 18,400 lb	5100 kg 11,200 lb		
-1.5 m -5'	2200 kg 4,800 lb	1450 kg 3,200 lb			2550 kg 5,600 lb	1700 kg 3,700 lb	3900 kg 8,600 lb	2500 kg 5,600 lb	8200 kg 18,100 lb	5000 kg 11,000 lb	*4750 kg *10,400 lb	*4750 kg *10,400 lb
-3.0 m -10'	2800 kg 6,200 lb	1850 kg 4,100 lb					4050 kg 8,900 lb	2650 kg 5,800 lb	*7850 kg *17,400 lb	5050 kg 11,100 lb	*8000 kg *17,700 lb	*8000 kg *17,700 lb

PC130-8 Arm: 3000 mm 9'10" Bucket: 0.5 m ³ 0.65 yd ³ SAE heaped Shoe: 500 mm 20" triple grouser												
B	⊗ MAX		7.6 m 25'		6.1 m 20'		4.6 m 15'		3.0 m 10'		1.5 m 5'	
	Cf	Cs	Cf	Cs	Cf	Cs	Cf	Cs	Cf	Cs	Cf	Cs
7.6 m 25'	*1850 kg *4,100 lb	*1850 kg *4,100 lb					*2050 kg *4,500 lb	*2050 kg *4,500 lb				
6.1 m 20'	*1500 kg *3,400 lb	*1500 kg *3,400 lb			*1850 kg *4,100 lb	*1850 kg *4,100 lb						
4.6 m 15'	*1400 kg *3,100 lb	1400 kg 3,100 lb			*2700 kg *6,000 lb	1950 kg 4,300 lb						
3.0 m 10'	*1400 kg *3,100 lb	1200 kg 2,600 lb	*1550 kg *3,400 lb	1200 kg 2,600 lb	2750 kg 6,100 lb	1900 kg 4,200 lb	*3400 kg *7,400 lb	3150 kg 6,900 lb				
1.5 m 5'	*1500 kg *3,300 lb	1100 kg 2,400 lb	1800 kg 3,900 lb	1150 kg 2,600 lb	2650 kg 5,900 lb	1800 kg 3,900 lb	4350 kg 9,600 lb	2900 kg 6,400 lb	*6650 kg *14,700 lb	5500 kg 12,100 lb		
0 m 0'	1700 kg 3,800 lb	1100 kg 2,400 lb	1750 kg 3,800 lb	1100 kg 2,500 lb	2550 kg 5,600 lb	1700 kg 3,700 lb	4100 kg 9,000 lb	2700 kg 5,900 lb	8350 kg 18,400 lb	5050 kg 11,200 lb		
-1.5 m -5'	1900 kg 4,100 lb	1200 kg 2,700 lb			2500 kg 5,500 lb	1600 kg 3,600 lb	3850 kg 8,500 lb	2450 kg 5,400 lb	8100 kg 17,800 lb	4850 kg 10,700 lb	*4150 kg *9,100 lb	*4150 kg *9,100 lb
-3.0 m -10'	2300 kg 5,100 lb	1500 kg 3,300 lb			2500 kg 5,500 lb	1600 kg 3,600 lb	3900 kg 8,600 lb	2550 kg 5,600 lb	8100 kg 17,900 lb	4850 kg 10,700 lb	*6750 kg *14,900 lb	*6750 kg *14,900 lb
-4.6 m -15'	*3350 kg *7,400 lb	2350 kg 5,100 lb					*3950 kg *8,700 lb	2650 kg 5,800 lb	*6250 kg *13,800 lb	5050 kg 11,100 lb		

* Load is limited by hydraulic capacity rather than tipping. Ratings are based on SAE Standard No. J1097. Rated loads do not exceed 87% of hydraulic lift capacity or 75% of tipping load.



STANDARD EQUIPMENT

- Air conditioner with defroster
- Alternator, 35 Ampere, 24 V
- Auto-decel
- Automatic engine warm-up system
- Batteries, 64 Ah/2 x 12 V
- Boom holding valve
- ROPS cab (ISO 12117-2)
- Counterweight
- Dry type air cleaner, double element
- Electric horn
- EMMS monitoring system
- Engine, Komatsu SAA4D95LE-5
- Engine overheat prevention system
- Fan guard structure
- Front underview mirror
- Hydraulic track adjusters (each side)
- Multi-function color monitor
- Power maximizing system
- PPC hydraulic control system
- Radiator and oil cooler dust proof net
- Rear reflector
- Rearview mirrors (RH, LH, rear, sidewise)
- Seat belt, retractable
- Slip-resistant plates
- Starting motor, 4.5 kW/24 V x 1
- Suction fan
- Track roller: 7 each side
- Track shoe: **500 mm 20"** triple grouser
- Travel alarm
- Working light, 2 (boom and RH)
- Working mode selection system



OPTIONAL EQUIPMENT

- Additional filter system for poor-quality fuel
- Alternator, 60 Ampere, 24 V
- Arms
 - 2500 mm 8'2"** arm assembly
 - 3000 mm 9'10"** arm assembly
- Batteries, large capacity
- Bolt-on top guard, [Operator Protective Guards level 2]
- Boom, **4600 mm 15'1"**
- Cab accessories
 - Rain visor
 - Sun visor
- Cab front guard
 - Full height guard
 - Half height guard
- Long lubricating intervals for work equipment bushing (500 hours)
- Rear view monitoring system
- Seat, suspension
- Service valve
- Shoes, triple grouser
 - 600 mm 24"**
 - 700 mm 28"**
- Track frame undercover
- Track roller guards (center section)
- Working lights
 - 2 on cab
 - 1 on counterweight



KOMATSU[®]