

KOMATSU®

WA900-8

Tier 4 Final Engine

WHEEL LOADER

WA900



Photos may include optional equipment.

HORSEPOWER

Gross: 672 kW 900 HP @ 2050 rpm
Net: 671 kW 899 HP @ 2050 rpm

OPERATING WEIGHT

256,618 lb
116400 kg

BUCKET CAPACITY

15.0 – 19.0 yd³
11.5 – 14.5 m³

WALK-AROUND

DESIGNED FOR INCREASED PRODUCTIVITY AND OPERATOR COMFORT

With the addition of a Modulation Clutch, Throttle Lock, and Closed-Center, Load Sensing Hydraulic System (CLSS), the WA900-8 can load more trucks per shift. A re-engineered operators cab with improved access, visibility, and features to enhance productivity keeps operators comfortable throughout long shifts.

WA900-8



Photos may include optional equipment.

HORSEPOWER

Gross: 672 kW 900 HP @ 2050 rpm
Net: 671 kW 899 HP @ 2050 rpm

OPERATING WEIGHT

256,618 lb
116,400 kg

BUCKET CAPACITY

15.0 – 19.0 yd³
11.5 – 14.5 m³



New Productivity and Efficiency Features

- Variable Traction Control System optimizes rim pull for various ground conditions, minimizing tire slippage and reducing maintenance costs
- Modulation Clutch gives operators precise control of rim pull, allows for fast work equipment speeds and a smooth approach when loading trucks
- A new Closed-Center, Load Sensing Hydraulic System (CLSS) keeps hydraulic oil cool, work equipment speed quick, and reduces fuel consumption
- Throttle Lock improves cycle times by maintaining high work-equipment performance and saves fuel with auto-deceleration
- Komatsu SmartLoader Logic helps reduce fuel consumption without compromising production
- All new Komatsu bucket design, with modified profile to maximize bucket fill factor and increase productivity

New Operator's Environment

- Large, ROPS/FOPS certified operator's cab with trainer seat provides a full view of the working area
- 45 degree power staircase (optional) and 45 degree walkways on left and right side of machine for convenient access to the cab
- Catwalks and guardrails on the counterweight and in front of the cab allow for easy maintenance
- Work equipment shock reduction control (4 settings – off, low, middle, high)
- Higher capacity air suspension seat (heated and ventilated)
- LED external and internal lighting
- Anchored tie off points (ISO 14567) located around the machine provide technicians locations to attach service lanyards
- Electronically Controlled Suspension System (ECSS) provides a smooth ride for better travel performance, reducing operator fatigue and material spillage during operation

Reliability and Durability

- Increased overhaul intervals on transmission and axles reduce the Total Cost of Ownership (TCO)
- New loader linkage design with increased arm plate width for structural durability in the most challenging digging applications
- Standard brake cooling and redesigned wet, multi-disk service brakes extend service intervals and require fewer service hours to complete planned maintenance
- Standard engine pre-lubrication system ensures full lubrication upon startup to minimize unnecessary engine wear

New Machine Technology

- Large 7" LCD color machine monitoring panel with integrated load meter
- Advanced machine monitoring system with onboard diagnostics, no laptop required
- KomVision with radar obstacle detection provides a bird's eye view utilizing a 6-camera system and dedicated display (optional)
- KOMTRAX Plus, for near-real time remote diagnostics of machine health and performance
- Energy saving operation and ecology guidance provides operator with recommendations to improve operational efficiency and fuel economy
- Automatic Dig, Semi-auto approach, and Semi-auto dump features automate work equipment control throughout a v-cycle to reduce operator fatigue while maintaining high levels of productivity

PRODUCTIVITY & EFFICIENCY FEATURES

NEW ENGINE TECHNOLOGIES

Komatsu's New Emission Regulation-compliant Engine

Komatsu provides a powerful and economical U.S. EPA Tier 4 Final compliant engine with the latest emission control technologies and fuel saving features.

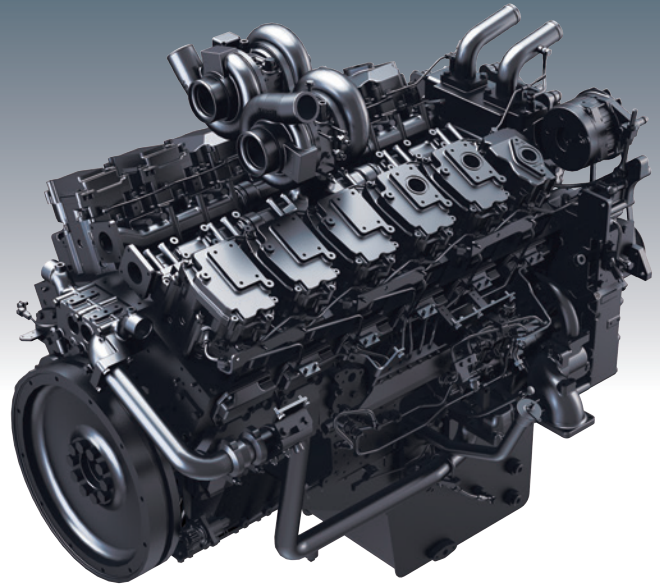

Heavy-Duty Aftertreatment System

The Komatsu Diesel Particulate Filters (KDPFs) capture more than 90% of Particulate Matter (PM). The KDPFs include a special oxidation catalyst to facilitate decomposition of most PM without operator action and no need to interrupt normal operation.

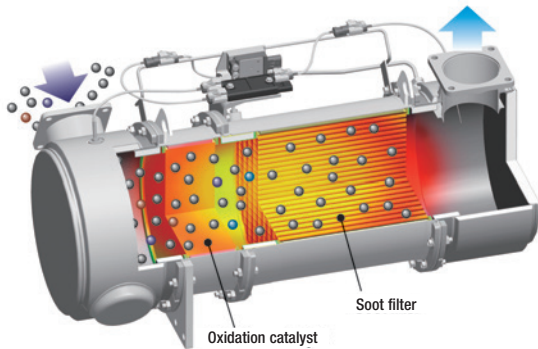

Variable Geometry Turbocharger (VGT) System

The VGT system uses proven, Komatsu-designed hydraulic technology for variable control of airflow and supplies optimal air based on load conditions.

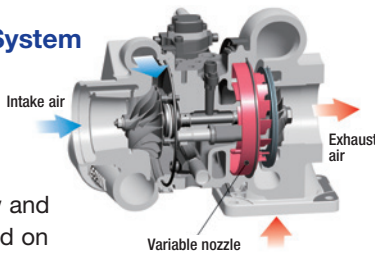

Heavy-Duty Cooled Exhaust Gas Recirculation (EGR) System

The system recirculates a portion of exhaust gas into the air intake and lowers combustion temperatures. The system reduces NOx emissions and lowers fuel consumption.

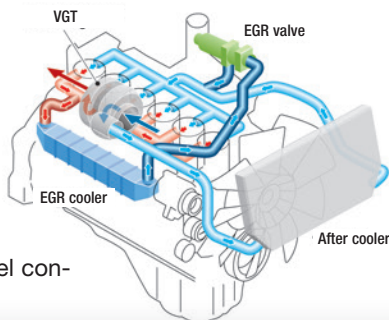

High Pressure Common Rail (HPCR) Fuel Injection System

The system is designed to achieve an optimal injection of high-pressure fuel via computerized control, providing near-complete combustion to reduce PM emissions.

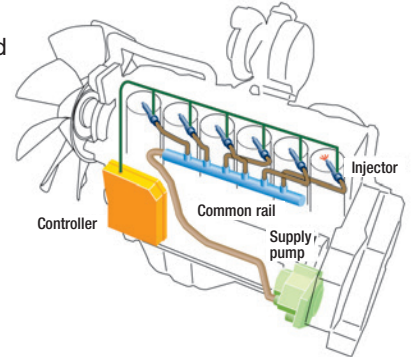

Low Fuel Consumption

By optimally controlling engine power and creating a high efficiency power train and hydraulic system, new features on the WA900-8 enhance fuel efficiency.

Komatsu SmartLoader Logic

The WA900-8 is equipped with Komatsu SmartLoader Logic, an engine control system. This technology outputs the correct engine torque for each work phase. For example, engine torque needs are higher for digging in V-shape loading, but less when driving with an empty bucket. Komatsu SmartLoader Logic functions automatically and does not interfere with operation, reducing fuel consumption while maintaining machine performance. When Komatsu SmartLoader Logic is enabled, the mode indicator on the machine monitor will automatically change between the Eco and Power icon depending on the demand of the application.

WA900-8

Variable Displacement Piston Pump & Closed Center Load Sensing System (CLSS)

The variable displacement piston pump combined with the closed-center load sensing system delivers hydraulic flow when it is needed. The variable displacement piston pump destrokes to minimize unnecessary hydraulic flow when not required, keeping hydraulic oil temperatures cool and reducing fuel consumption.

Fuel consumption (gal/hour)

Reduced by up to 10%

*Compared with the WA900-3E0 and with Komatsu SmartLoader Logic enabled on the WA900-8. Fuel Consumption varies depending on working conditions.

Tire Slip Control System

This system is effective for extending the service life of tires. It senses tire slip with a speed sensor, then controls the torque converter with the modulation clutch.



Large-capacity Torque Converter

The Komatsu designed power train has a large capacity torque converter for efficient travel performance and increased tractive effort when digging.

Redesigned Komatsu Bucket

The redesigned Komatsu bucket provides improved productivity and durability. The bucket has a new shape with an increased radius and floor inclination that make the bucket easier to fill and improves material retention. The spill guard design was adjusted to give operators improved visibility to the pile. Sweeper wings on either side of the bucket help to protect the front tires.



Automatic Digging System

New automatic digging system actuates the bucket tilt and lifting operations by sensing the pressure applied to the work equipment. This system can alleviate the operator's fatigue and optimize bucket load. It can easily be activated or deactivated on the right hand console and can be used independently of the Semi-auto Approach or Semi-auto Dump Systems.

Semi-auto Approach System

The Semi-auto Approach system raises the boom automatically when reversing out of the pile in v-cycle truck loading applications. The speed at which the boom raises is adjustable based on tire rotation (slow, standard, fast). The lift arms will raise until reaching the upper setting of the boom positioner, resulting in lower operator fatigue and allowing the operator to focus on the travel path of the loader. This system can easily be activated or deactivated on the right hand console and can be used independently of the Automatic Digging or Semi-auto Dump Systems.

Semi-auto Dump System

The Semi-auto Dump system automatically raises the lift arms and dumps the bucket when the left inside button of the bucket lever is pressed. The bucket automatically levels and the lift arms return to the lower boom positioner setting. The lift arms will not lower until the bucket has cleared the truck because it is based on tire rotation. This system enables easy dumping operation and reduces operator fatigue. It can easily be activated or deactivated from the right hand console and can be used independently of the Automatic Digging or Semi-auto Approach Systems.

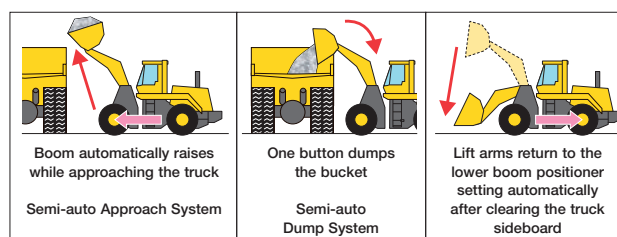

Fuel efficiency (ton/gal)

Increased by 17%

*Compared with the WA900-3E0

The new productivity features on the WA900-8 in combination with the features to reduce fuel consumption result in a 17% improvement in fuel efficiency compared to the WA900-3E0.

OPERATOR ENVIRONMENT



New Operator Seat with Electronic Pilot Control (EPC) Levers

A new air suspension, heated and ventilated operator seat provides enhanced support on rough roads and dampens machine vibrations resulting in a more comfortable ride for the operator. An EPC lever console and advanced joystick steering lever are integrated in and move with the seat. The angle of the armrest is fully adjustable for optimum operator comfort.



Advanced Joystick Steering System (AJSS)

The Advanced Joystick Steering System (AJSS) allows steering and directional selection to be controlled by the operator's left hand. With the feedback function, the machine steering angle matches the angle of the joystick.

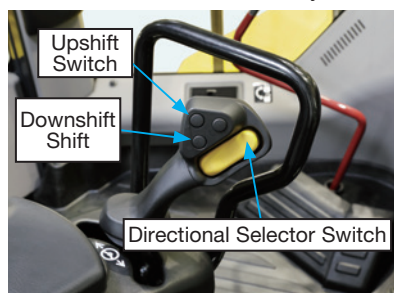

Low Noise Design

The large cab is mounted with Komatsu's unique viscous mounts. The engine, hydraulically driven fan, and hydraulic pumps are mounted with rubber cushions. The cab sealing has been improved to provide a quiet, low-vibration and comfortable operator environment. The cab is pressurized to minimize dust intrusion.

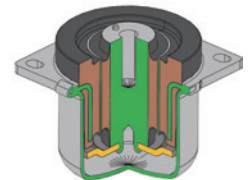

Operator's ear noise level	73 dB(A)
Dynamic noise level (outside)	115 dB(A)

Operator's ear - ISO 6396:2008

Dynamic - ISO 6395:2008

* at 70% max fan speed

Integrated Load Meter

The Komatsu integrated load meter system displays payload data directly on the monitor panel. Payload data is also accessible remotely via KOMTRAX Plus.



Large ROPS/FOPS Cab

The ROPS/FOPS certified cab is standard equipment on the WA900-8. Walkways with handrails on the front and rear of the machine provide easy access to the cab.

A wide pillar-less flat glass window provides excellent front visibility. Heated mirrors and heated rear window provide excellent visibility in cold weather conditions.

ROPS (ISO 3471): Rollover Protective Structure

FOPS (ISO 3449): Falling Objects Protective Structure



Non-glare Bucket Treatment

The Komatsu buckets come standard with non-glare paint. This reduces the effect of the reflection of the work lamps when working in dark environments.

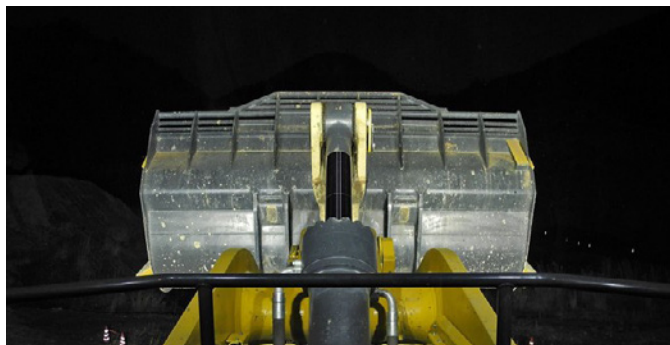

Power Staircase

An optional hydraulic staircase is available for improved machine access. The integrated ladder prevents the parking brake from being released when in the down position.



Trainer Seat

A trainer seat with lap belt is standard equipment. It can be folded up when not in use.



Radio with Bluetooth & AUX Inputs

The AM/FM radio is equipped with bluetooth and aux inputs allowing the operator to connect to the speakers in the cab.



LED Room Lamp and Spot Lamp

LED lamps in the cab are standard.



Automatic Climate Control System

The automatic climate control system allows the operator to set the desired cab temperature.

Standard Equipment

Lunch box tray



Hot or cool box



- ① 12 V outlets
- ② Auxiliary input (MP3 jack)
- ③ Auxiliary input (USB jack)

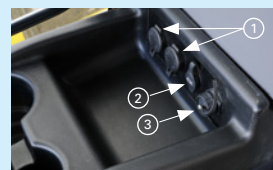

Front, side, and rear windshield wipers



Secondary engine shutdown switch



Parking brake switch



OPERATOR ENVIRONMENT

Work Equipment Shock Reduction Control

Stroke-end shock of the work equipment can be adjusted to reduce operator fatigue and accommodate different loading applications. There are four settings: Low, Medium, High, and Off. The operator can select the setting through the monitor panel.



Throttle Lock with Auto Deceleration

Low idle engine RPM can be set using the Throttle Lock switch located on the right console. Auto deceleration reduces engine to 680 RPM automatically if no operator command is sensed after ten seconds for additional fuel savings.



Variable Traction Control System

Machine rim pull can be set between 100% tractive effort down to 20% using the variable traction control system knob. Setting the correct rim pull to match underfoot conditions reduces tire slippage for increased tire life.



Remote Bucket & Boom Positioner with Shockless Stop Function

The operator can set the bucket angle and remote boom positioner from the cab. Once the positioner is set, the bucket is smoothly stopped at the desired position with no shock. Both the upper and lower boom positions are adjustable in the cab with the push of a button.

Automatic Transmission

The automatic transmission with electronically controlled modulation valve (ECMV) automatically selects the proper gear based on travel speed, engine speed, and other travel conditions. The ECMV engages the clutch smoothly to prevent lag and shock when shifting gears. This system provides efficient machine operation and a comfortable ride. The mode select system allows operator to select manual shifting or automatic shifting.

Auto Kick-down Control

Down-shifting from second to first gear can be done automatically using the auto kick-down feature when beginning the digging cycle. The WA900-8 will automatically shift from first gear back to second gear when put in reverse. Digging in first gear results in better bucket penetration and reversing out of the pile in second gear reduces cycles time for increased production. Manual kick-down can be accomplished using the kick-down button located on the boom control lever.

Electronically Controlled Suspension System

The electronically controlled suspension system uses an accumulator which absorbs the shock in the boom arm, giving the operator a much smoother ride. This reduces operator fatigue and reduces material spillage during load-and-carry operations. The electronically controlled suspension system is speed sensitive, ensuring that the boom cushioning function doesn't interfere with stationary digging.

Modulation Clutch

The modulation clutch adjusts the tractive effort using the left brake pedal from 100% to 20% of the torque converter output torque.

- Useful for a smooth approach when loading haul trucks.
- Provides simple control of tire slippage.
- Reduces shock when shifting from forward to reverse.

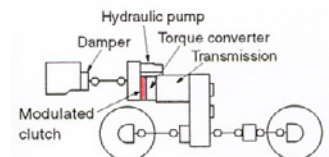
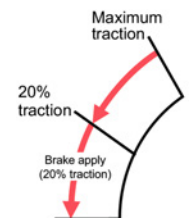

LED Lighting Package

22 LED work lamps provide excellent visibility in various working conditions.



Rear View Monitoring System

The operator can view the rear working area of the machine with a full color monitor located on the right side of the cab. This monitor can be always on or only on when in reverse. Visual guidelines can be added for additional guidance. The rear view monitoring system is standard and uses a separate camera and dedicated monitor from KomVision with Radar Obstacle Detection system.



KOMVISION MONITOR

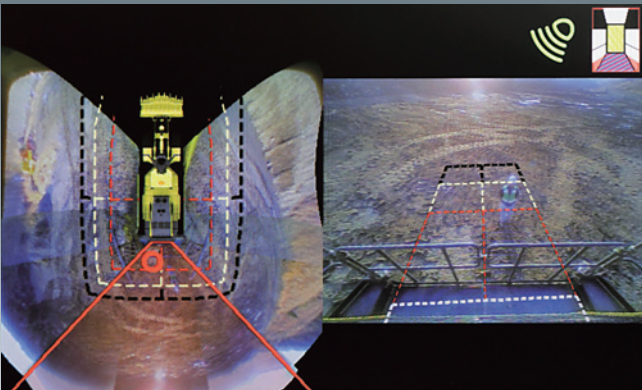

KomVision with Radar Obstacle Detection

KomVision with Radar Obstacle Detection (optional) is a six-camera system that provides the operator with a bird's-eye view of the machine and surrounding working area on a dedicated monitor. Radar obstacle detection provides an audible in cab alert when an object is detected by any of the four radar panels. KomVision with Radar Obstacle Detection improves operator situational aware on the jobsite.



KomVision Camera



Radar Panel

TECHNOLOGY

WAG900-8

High Resolution 7-inch Color LCD Monitor

The machine monitor displays various machine information and allows for various settings of the machine. The LCD monitor is a 7-inch color LCD and displays maintenance information, operation records, and ecology guidance records. The switch panel is used to select various screens and the air conditioner control screen. By using the switch panel, users can display various user menus on the LCD screen and adjust machine settings.

Machine monitor

- | | |
|---------------------------|---|
| 1 LCD unit | 8 Engine coolant temperature gauge |
| 2 LED unit | 9 Hydraulic oil temperature gauge |
| 3 Engine tachometer | 10 Torque converter oil temperature gauge |
| 4 Speedometer | 11 Fuel gauge |
| 5 Ecology gauge | 12 Message pilot lamp |
| 6 Air conditioner display | 13 Pilot lamps |
| 7 Shift indicator | |

Switch panel

- | | |
|--|---------------------|
| 1 Air conditioner switches / Numeral key pad | 2 Function switches |
|--|---------------------|



Visual User Menu

Pressing the menu switch on the switch panel displays the user menu screen. The menus are grouped for each function, and use easy-to-understand icons which enable the machine to be operated intuitively.

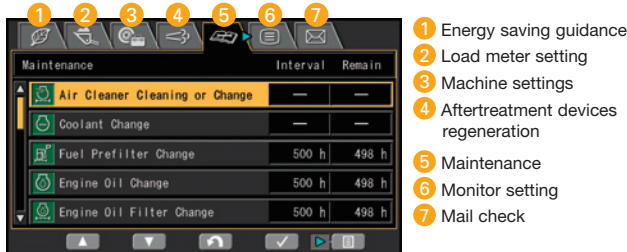

Energy Saving Operation Ecology Guidance

In order to support optimum operation, an easy-to-read "Ecology gauge" is displayed on the machine monitor screen. In addition, the following five guidance messages are displayed for fuel saving operation.

- 1) Excessive engine idling event
- 2) Hydraulic relief pressure event
- 3) Dragging of brake event
- 4) Excessive stepping on accelerator event
- 5) Excessive digging event



Machine Monitor with Troubleshooting Function to Minimize Downtime

Various meters, gauges, and warning functions are centrally arranged on the machine monitor. The monitor simplifies start-up inspection and promptly warns the operator with a lamp and buzzer if any abnormalities should occur. In addition, abnormalities are indicated in four levels to identify proper level and urgency of response.



Operator Identification Function

Operator identification can be used to track operator performance and machine utilization. The data is transmitted via KOMTRAX Plus and can be used to analyze machine operation information by operator.



Operation Records, Fuel Consumption History, and Ecology Guidance Records

The ecology guidance menu enables the operator to check fuel consumption history, operation, and ecology guidance records. The records can be used to reduce overall fuel consumption.

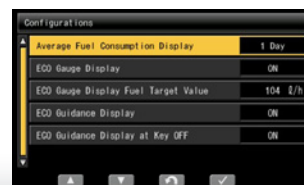

MAINTENANCE FEATURES



Side-opening Engine Bay Doors

The wide access areas on both the left and right sides of the engine and standard LED engine bay lamps make daily maintenance easy. Large steps are provided on each side of the frame for additional convenience.



Left



Right

Anchorage Points

Nine ISO 14567 certified anchorage points for service lanyard tie-offs are located throughout the machine.



Reversing Fan

The engine cooling fan is driven hydraulically. The reversible fan can be controlled through the monitor.

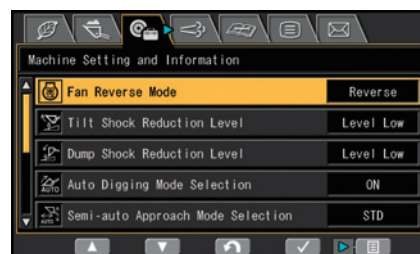

Battery and Starter Isolators

Battery and starter isolators are located on the left side at the primary ingress location of the machine. The battery isolator disconnects power when performing service work on the machine. The starter isolator allows for cab power but prevents the engine from starting. Padlocks can be installed to lockout the machine.



Machine Immobilization Switch

The machine immobilization switch is located near the right side battery box. When activated, the transmission, steering, and work equipment are locked out. A status indicator lamp shows the state of the machine immobilization switch.



MAINTENANCE FEATURES

Swing-out Type Cooling Fan and Wide Core Radiator

The cooling fan swings out for easy cleaning. Wide cooling fin spacing reduces clogging.



Engine Compartment

The WA900-8 engine compartment is configured for easy serviceability. Special attention was paid to the location of maintenance items such as the filters, dipsticks, and oil fill locations. The aftertreatment components are also easy to access.



Rear Full Fenders

Rear full fenders with steps and handrails are standard on both sides of the machine. The fenders protect the machine from materials that may be thrown by the tires and give technicians easy access to the engine compartment.



Fast Fuel System

The refueling port can be accessed from the ground level for reduced fueling time with the fast fill fuel coupler.



Modular Radiator Core System

The modular core radiator allows for individual cores to be replaced without the need to remove the entire radiator assembly.



Ground Level Service Center

Fill and drains for the transmission oil, hydraulic oil, engine oil, and coolant are accessible at the ground level service center. The auto-lubrication grease fill and live oil sampling ports are arranged to significantly reduced maintenance time.



Maintenance Information

“Maintenance time caution lamp” display

When the remaining time to maintenance becomes less than 30 hours*, the maintenance time monitor icon illuminates. Pressing the menu switch displays the maintenance screen.

* : The setting can be changed within the range between 10 and 200 hours.



Maintenance icon

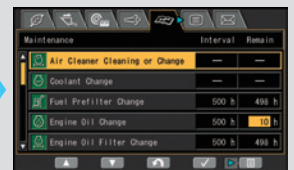

Maintenance screen

KOMTRAX EQUIPMENT MONITORING

GET THE WHOLE STORY WITH
KOMTRAX®

✓ **WHAT**

- KOMTRAX is Komatsu's remote equipment monitoring and management system
- KOMTRAX **continuously monitors and records** machine health and operational data
- Information such as fuel consumption, utilization, and a detailed history **lowering owning and operating cost**

✓ **WHEN**

- Know when your machines are **running or idling** and make decisions that will improve your fleet utilization
- Detailed movement records ensure you know when and where your equipment is moved
- Up to date records allow you to **know when maintenance is due** and help you plan for future maintenance needs

✓ **WHERE**

- KOMTRAX data **can be accessed virtually anywhere** through your computer, the web or your smart phone
- Automatic alerts keep fleet managers up to date on the latest machine notifications

✓ **WHO**

- KOMTRAX is **standard** equipment on all Komatsu construction products



✓ **WHY**

- Knowledge is power - **make informed decisions** to manage your fleet better
- Knowing your idle time and fuel consumption will help maximize your machine efficiency
- **Take control of your equipment** - any time, anywhere

KOMTRAX Plus®

Assists Customer's Equipment Management and Contributes to Fuel Cost Cutting

Equipment Management Support

KOMTRAX Plus enables expanded monitoring of the fleet via satellite and wireless LAN. Users can analyze "machine health" and performance from a remote location, on a near-real time basis. This includes component condition and trend data. By making this critical information readily accessible, KOMTRAX Plus is an effective tool in maximizing productivity and lowering operating costs.

SPECIFICATIONS



ENGINE

Model.....Komatsu SAA12V140E-7*
 Type.....Water-cooled, 4-cycle
 Aspiration.....Turbo-charged,
 after-cooled, cooled EGR
 Number of cylinders.....12
 Bore.....140 mm **5.51"**
 Stroke.....165 mm **6.50"**
 Piston displacement.....30.48 ltr **1860 in³**
 Governor.....All-speed, electronic
 Horsepower:
 SAE J1995.....Gross 672 kW **900 HP**
 ISO 9249 / SAE J1349.....Net 671 kW **899 HP**
 Rated rpm.....2050 rpm
 Fan drive method for radiator cooling.....Hydraulic
 Fuel system.....Direct injection
 Lubrication system:
 Method.....Gear pump, force-lubrication
 Filter.....Full-flow type
 Air cleaner.....Dry type with double elements and
 dust evacuator, plus dust indicator

*EPA Tier 4 Final emissions certified



TRANSMISSION

Torque converter.....Three-elements, one-stage, one-phase
 Transmission.....Full-powershift, planetary type

Travel speed	Forward*	Reverse*
1st	7.6 km/h 4.7 mph	7.9 km/h 4.9 mph
2nd	11.9 km/h 7.4 mph	12.1 km/h 7.5 mph
3rd	23.3 km/h 14.5 mph	24.1 km/h 15.0 mph

*P-mode Measured with 45/65-R45 tires



AXLES AND FINAL DRIVES

Drive system.....Four-wheel drive
 Front.....Fixed, full-floating
 Rear.....Center-pin support, full-floating,
 20° total oscillation
 Reduction gear.....Spiral bevel gear
 Differential gear.....Conventional type
 Final reduction gear.....Planetary gear, single reduction



BRAKES

Service brakes.....Hydraulically actuated,
 wet multiple-disc brakes actuate on four wheels
 Parking brake.....Wet multiple-disc brake



STEERING SYSTEM

Type.....Articulated type, fully-hydraulic power steering
 Steering angle.....40° each direction
 Minimum turning radius at
 the center of outside tire.....9880 mm **32' 5"**



HYDRAULIC SYSTEM

Steering system:
 Hydraulic pump.....Piston type
 Capacity.....2 x 220 ltr/min **58.1 U.S. gal/min** at rated rpm
 Relief valve setting.....34.3 MPa 350 kgf/cm² **4,975 psi**
 Hydraulic cylinders:
 Type.....Double-acting, piston type
 Number of cylinders.....2
 Bore x stroke.....160 mm x 576 mm **6.3" x 22.7"**

Work Equipment control:
 Hydraulic pump.....Piston pump
 Capacity.....4 x 230 ltr/min **60.8 U.S. gal/min**
 at rated rpm
 Relief valve setting.....34.3 MPa 350 kgf/cm² **4,975 psi**
 Hydraulic cylinders:
 Type.....Double-acting, piston type
 Number of cylinders—bore x stroke:
 Lift cylinder.....2 - 260 mm x 1495 mm **10.2" x 58.9"**
 Bucket cylinder.....1 - 300 mm x 995 mm **11.8" x 39.2"**
 Control valve.....Spool type
 Control positions:
 Boom.....Raise, hold, lower, and float
 Bucket.....Tilt-back, hold, and dump
 Hydraulic cycle time (rated load in bucket)
 Raise.....10.1 s
 Dump.....2.9 s
 Lower (Empty).....4.8 s



SERVICE REFILL CAPACITIES

Cooling system.....370 ltr **97.7 U.S. gal**
 Fuel tank.....1555 ltr **410.8 U.S. gal**
 Engine.....120 ltr **31.7 U.S. gal**
 Hydraulic system.....1020 ltr **269.5 U.S. gal**
 Axle front.....370 ltr **97.7 U.S. gal**
 rear.....370 ltr **97.7 U.S. gal**
 Torque converter and transmission.....180 ltr **47.6 U.S. gal**



BUCKET SELECTION GUIDE

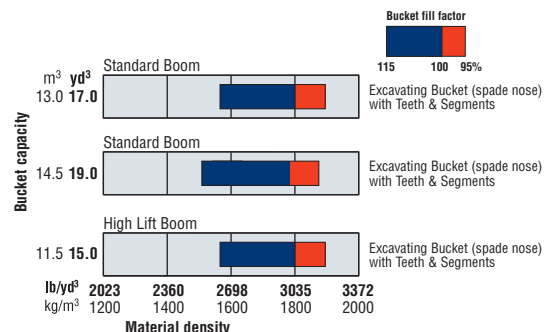



DIMENSIONS

Measured with 45/65 R45 (L-5) tires, ROPS/FOPS (ISO 3471/ISO 3449) cab

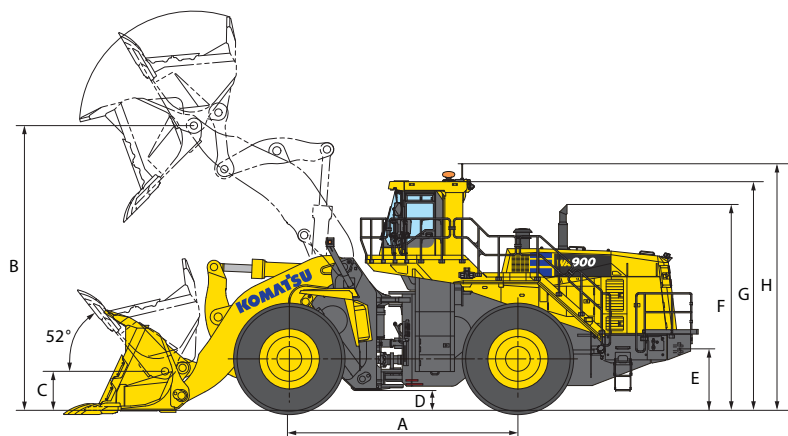

Tread width (center of tread to center of tread)	3350 mm	11'0"
Width over tires	4585 mm	15'1"
A Wheelbase	5600 mm	18'4"
B Hinge pin height,	Standard boom 6975 mm	22'11"
max. height	High lift boom 7485 mm	24'7"
C Hinge pin height,	Standard boom 955 mm	3'2"
carry position	High lift boom 1050 mm	3'5"
D Ground clearance	485 mm	1'7"
E Hitch height	1510 mm	4'11"
F Overall height, top of the stack	5040 mm	16' 6"
G Overall height, ROPS cab	5600 mm	18' 4"
H Overall height, Antenna	6035 mm	19' 10"

	Standard Boom	High Lift Boom
	Excavating Bucket	Excavating Bucket
	Spade nose Teeth and Segments	Spade nose Teeth and Segments
Bucket capacity: heaped	13.0 m ³ 17.0 yd³	11.5 m ³ 15.0 yd³
struck	11.0 m ³ 14.4 yd³	9.9 m ³ 12.9 yd³
Bucket width	4935 mm 16'2"	4935 mm 16'2"
Bucket weight	13115 kg 28,914 lb	12215 kg 26,930 lb
Dumping clearance, max. height and 45° dump angle *1	4610 mm 15'1"	5225 mm 17'2"
Reach at max. height and 45° dump angle *1	2685 mm 8'10"	2555 mm 8'6"
Reach at 2130 mm 7' clearance and 45° dump angle	3970 mm 13'0"	4240 mm 13'11"
Reach with arm horizontal and bucket level *1	5245 mm 17'2"	5445 mm 17'10"
Operating height (fully raised)	9780 mm 32'1"	10155 mm 33'4"
Overall length (bucket on ground)	15355 mm 50'5"	15610 mm 51'3"
Loader clearance circle (bucket at carry, outside corner of bucket)	23340 mm 76'7"	23640 mm 77'7"
Digging depth: *2 0°	225 mm 9"	225 mm 9"
10°	660 mm 2'2"	630 mm 2'1"
Static tipping load: straight	71840 kg 158,380 lb	65620 kg 144,667 lb
40° full turn	63610 kg 140,236 lb	58100 kg 128,089 lb
Breakout force	71900 kgf 158,511 lb	77000 kgf 169,754 lb
Operating weight	116400 kg 256,618 lb	116720 kg 257,324 lb

*1 At the end of tooth. *2 At the end of segment edges.

All dimensions, weights, and performance values based on ISO 7131 and 7546 standards.

Static tipping load, operating weight and overall length shown include lubricant, coolant, full fuel tank, ROPS (ISO 3471) cab and operator. Machine stability and operating weight affected by counterweight, tire size, and other attachments.



STANDARD EQUIPMENT FOR BASE MACHINE

ENGINE AND RELATED

COMPONENTS:

- Air Cleaner, Double Element with Dust Indicator and Evacuator
- Engine, KOMATSU SAA12V140E-7, 12 Cylinder, Turbocharged, After Cooled, Diesel
Gross HP: **900HP** (672kW) / 2050 RPM (SAE J1995)
Net HP: **899 HP** (671kW) / 2050 RPM (ISO 9249 / SAEJ1349)
- Engine Pre-lubrication System
- Exhaust Pipe Glasswooled with 2 x KDPF/KDOC
- Fuel Pre-Filter with Water Separator
- Hydraulic Cooling Fan, Reversible, Swing Out
- Radiator, Modular Core, Swing Out Lattice Type Mask

ELECTRICAL SYSTEM:

- Access Stair Lamps, (1 RH & 2 LH)
- Alternator, 24V (140 Ampere)
- Back-up Alarm
- Back-up Lights, Rear, LED
- Batteries, 4 x 12V, (160Ah)
- Beacon, Amber Color
- Circuit Breaker
- Emergency Stop Switches, Ground Level (RH & LH)
- Heavy Duty Wiring Harness
- Horn, Electric
- Instrument Monitor Panel, Multi Color Display
- Secondary Shutdown Switch, Engine, Cab Mounted
- Starting Motors, 11kW / 2 x 24V, Direct Electric
- Stop and Tail Lights, LED
- Turn Signals, (2 Front, 2 Rear) with Hazard Switch, LED
- Work Lamps, LED, 22:
6 Front Work Lamps (3 RH & 3 LH)
6 Rear Work Lamps (3 RH & 3 LH)
4 Side Work Lamps (2 RH & 2 LH)
2 Axle Mounted Work Lamps (Front)
4 Cab Mounted Work Lamps (2 Front & 2 Rear)

POWER TRAIN & CONTROLS:

- 3rd gear prohibition and speed limit control
- Brake Cooling
- Brake, Parking, Wet Multiple Disc, SAHR
- Brakes, Service, Wet Multiple Disc, Sun Gear
- Powertrain Underguard
- Secondary Steering (ISO 5010)
- Steering, Advanced Joystick Steering System (AJSS)
- Transmission, 3-speed Planetary Automatic Powershift Modulation Clutch Kickdown, Automatic and Manual Control
- Throttle Lock with Auto Deceleration
- Variable Traction Control System

OPERATOR ENVIRONMENT:

- 45 Degree Stairways (LH & RH)
- Access Ladder (LH & RH)
- Cab, Steel, LH Entrance, ROPS/FOPS (ISO 3471/ISO 3449) 2 x DC12V Outlets, Auto Air Conditioner, Heater, Defroster (Front & Rear), Blinds, Front & Rear with Roll Curtains, Ecology Guidance, Ecology Gauge Lever, Machine Lockout
- Main Monitor - Multi Color Electronic Display Onboard Diagnostics
- Power Windows
- Radio, AM/FM with Bluetooth
- Rearview Mirrors, RH & LH, Heated
- Rearview Camera Monitoring System (Dedicated Monitor)
- Room/Spot Lamps, LED
- Seat, Air Suspension, Reclining, Heated / Ventilated
- Seat Belt, 3" Retractable, Lap Belt with Detachable Shoulder Harness
- Secondary Door, RH
- Sunvisor
- Trainer Seat with Retractable Lap Belt
- Wiper/Washer Front (Intermittent), Side, Rear (Intermittent)

MAINTENANCE:

- Anchor Points, Tie Off Type
- Battery Isolator, Lockable
- Engine Bay Lamps, LED
- Fast Fuel System
- Ground Level Service Center: Grease Gauge, Indicator Lamp, Refill Port, Centralized KOWA Sampling Fluids Ports, Transmission, Hydraulic & Engine Oil, Torque Converter & Engine Coolant
- Jump Start Receptacle
- Machine Immobilization Switch, Lockable
- Starter Isolator, Lockable)

HYDRAULICS & WORK EQUIPMENT:

- 2-spool Valve for Boom and Bucket with Electronic Pilot Controls
- Automatic Digging System
- Boom Positioner with Kick-Out
- Bucket Positioner with Kick-Out
- Electronically Controlled Suspension System (ECSS)
- Inline Filters, Steering and Hydraulic
- Semi-Auto Approach and Dump System
- Wall Digging Protection Control
- Work Equipment Shock Reduction Control

OTHER STANDARD EQUIPMENT:

- Auto Idle Shutdown
- Auto-Lubrication System
- Front Fenders (LH & RH)
- Komatsu SmartLoader Logic
- KOMTRAX Plus
- Load Meter System
- Platform, Counterweight with Handrails
- Platform, Front with Handrails
- Rims for 45/65-45 Tires
- Tow Hitch

VANDALISM PROTECTION:

- Battery Box Lock
- Cap Lock & Cover for Fuel Tank
- Radiator, Filler Lock and Cover



OPTIONAL EQUIPMENT

- 15.0 yd³ bucket
- 17.0 yd³ bucket
- 19.0 yd³ bucket
- 45/65R45 (L-5) tubeless tires
- 45 deg Power Staircase
- Cold weather arrangement (electric heaters for hydraulic oil, transmission oil, engine oil, and coolant)
- High lift boom
- KomVision (with radar)

AESS935-01

©2020 Komatsu America Corp.

AD02(Electronic View Only)

02/20 (EV-1)

KOMATSU®

Note: All comparisons and claims of improved performance made herein are made with respect to the prior Komatsu model unless otherwise specifically stated.

www.komatsuamerica.com

Komatsu America Corp. is an authorized licensee of Komatsu Ltd. Materials and specifications are subject to change without notice.

KOMATSU, Komatsu Care®, KOMTRAX® and KOMTRAX Plus® are registered trademarks of Komatsu Ltd. All other trademarks and service marks used herein are the property of Komatsu Ltd., Komatsu America Corp. or their respective owners or licensees.

WA900-8